

# SECTION 1: PRESCHOOL

This portion of the *Prosody Treatment Program* is appropriate for working with children ages 3-5.

## MUSICAL INSTRUMENTS

Playing musical instruments can help a child become more aware of rhythm and pitch. It provides a great opportunity for the child to experiment with the concepts *slow* and *fast* and *quiet* and *loud* as well as melodic patterns.

### Clinician Tips

- Provide opportunities for children to use instruments they will be able to play with minimal instruction, such as maracas, bongos, tambourines, and glockenspiels.
- Model simple patterns and see if the child can imitate them (e.g., quiet-quiet-loud, quiet-loud-quiet-loud).
- Help the child nurture an interest in musical instruments by making instruments that he can use to experiment with sound.
  - Create drums out of empty cans or cartons with plastic lids (e.g., coffee cans, oatmeal cartons). The child can decorate his drum with paper, paint, markers, or crayons.
  - Use rubber bands and a shoe box to create a guitar. Find four to six rubber bands of different widths, and cut a hole in the center of the shoebox lid. Help the child wrap the rubber bands lengthwise around the box and the lid, over the hole, leaving approximately  $\frac{1}{2}$  inch between each band. Slide a pen or pencil under the rubber bands a few inches from the hole to create a bridge.
  - Make a kazoo with an empty paper towel or toilet paper roll and waxed paper. Let the child decorate the outside of the kazoo with markers. Then place a piece of waxed paper over one end of the roll and secure it with a rubber band. Poke two or three small holes in the waxed paper to allow for sound production.
  - Pour small stones, beans, popcorn kernels, or rice into an empty and dry plastic bottle, and seal with the lid.

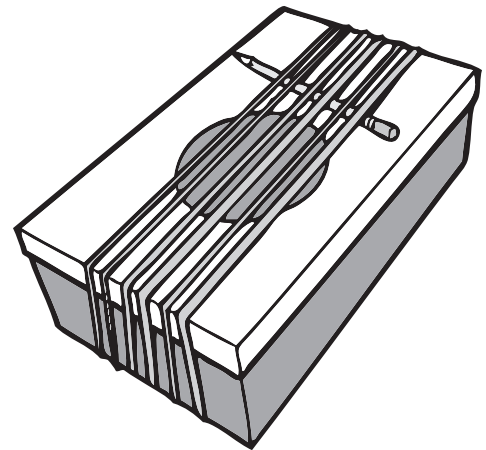

When you're doing these activities with the child, provide specific feedback regarding the sounds he's making, such as "That was nice and slow," "That was really fast," and "You held that note for so long."

# LOUDNESS 5

## Clinician Instructions

Read the directions to the client. Then read each situation, and score the items with + or – in the table as the client responds.

## Client Directions

Let's practice using your levels 1, 2, 3, and 4 voices. We're not going to practice your level 5 voice, shouting, because that can harm your voice. Listen as I describe some different situations. For each one, follow my directions using the correct voice level.

	Date				
1. Pretend you're at a bookstore. You're standing very close to your friend. Use a voice that's a little quiet to tell him about a book that you like.					
2. Pretend you're playing basketball. You need one more person for your team. You see your friend far away. Use a voice that's a little loud to ask him if he wants to join the game.					
3. Pretend you're in a room with a sleeping baby. Whisper to ask someone for a drink of water.					
4. Pretend you're at school. The teacher asks you to describe your favorite game. Use a regular voice to tell her about your favorite game.					
5. Pretend your friend has ketchup on his face. You want to tell him, but you don't want other people to hear because it could embarrass him. Tell him using a whisper voice.					
6. Pretend you're at a nice restaurant with your family. People in the restaurant are speaking quietly so they don't disturb other diners. Use a voice that's a little quiet to ask someone to pass you the ketchup.					
7. Pretend you're at a party and there's loud music playing. Use a voice that's a little loud to ask someone where the bathroom is.					
8. Pretend you're at a clothing store with your aunt. You want to ask her if she likes a shirt you picked out. Ask her using your regular voice.					
9. Pretend you're in the waiting room at a doctor's office. Use a voice that's a little quiet to ask someone to hand you a magazine.					
10. Pretend you're at home. You want to ask your brother to watch a movie with you. Ask him using your regular voice.					
<b># correct</b>	/10	/10	/10	/10	/10
<b>% correct</b>	%	%	%	%	%

## HIGH/LOW 3a

### Clinician Instructions

Give the client a copy of High/Low 3b on page 67, and read him the directions, modeling appropriate pitch levels in the example. Have the client repeat the example, and then say the remaining sentences without a model. Score the items with a + or – in the table as the client responds. The pitch pattern the client should use for each item is indicated.

*Note: Don't model extreme high and low contrasts. Keep the two pitches fairly close when you read the directions, and say the first item as an example.*

### Client Directions

Let's practice saying some sentences using a high- and low-pitch voice. Look at the words and pictures in each line. Read the word under each picture with the appropriate voice. Remember, when you see a balloon, say the word in a higher voice. When you see feet, say the word in a lower voice. I'll do the first one as an example. Then you try it.

1.     
 Are you cold?

	Date				
1. (low – low – high) Are you cold?					
2. (high – high – low) I don't know.					
3. (low – high – low) I lost it.					
4. (low – high – low) It's my turn.					
5. (low – low – high) Are you sad?					
6. (high – low – low) You get it.					
7. (low – high – low) I did it.					
8. (high – high – low) You broke it.					
9. (low – high – low) I'm not sick.					
10. (low – low – high) Is he home?					
<b># correct</b>	/10	/10	/10	/10	/10
<b>% correct</b>	%	%	%	%	%

# Sarcasm Homework

Cut out the cards and put them facedown in a pile on the table. Draw a card, and read the sentence to an adult partner using either a sincere or sarcastic voice. Have your partner tell you whether you're being sincere or sarcastic before you show the picture on the card.



This puppy is so cute.



This puppy is so cute.

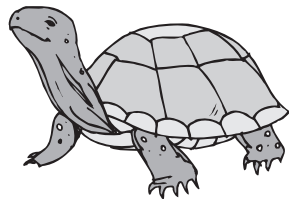

This animal is fast.

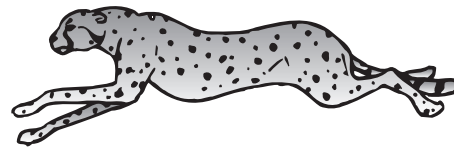

This animal is fast.



The cookie is really big.

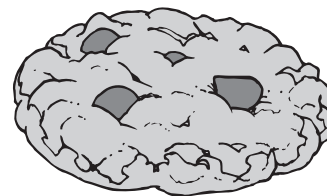

The cookie is really big.

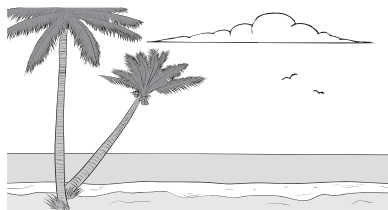

It's very sunny today.

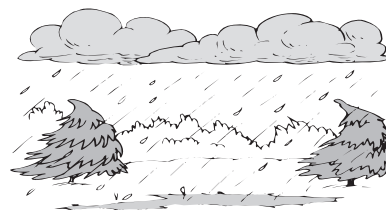

It's very sunny today.

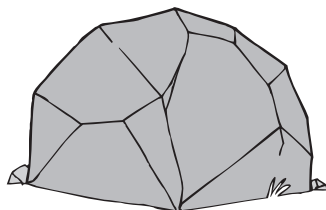

This is heavy.

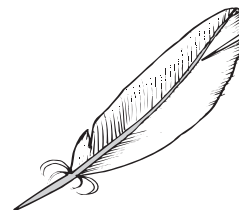

This is heavy.